

THIS IS A TWO-SIDED DOCUMENT

 Adirondack Park Agency P.O. Box 99, 1133 NYS Route 86 Ray Brook, New York 12977 Tel: (518) 891-4050 www.apa.ny.gov	APA Permit 2024-0300
In the Matter of the Application of ALAN SAMPICA, Estate of LORRAINE SAMPICA, BRITTANY LOCKLIN and BENJAMIN LOCKLIN Permittees for a permit pursuant to § 809 of the Adirondack Park Agency Act	Date Issued: December 23, 2024 To the County Clerk: Please index this permit in the grantor index under the following name(s): 1. Alan Sampica 2. Brittany Locklin 3. Benjamin Locklin

SUMMARY AND AUTHORIZATION

This permit authorizes the construction of a single family dwelling in an area classified Resource Management on the Adirondack Park Land Use and Development Plan Map in the Town of Saranac, Clinton County.

This authorization shall expire unless recorded in the Clinton County Clerk's Office within 60 days of issuance of a signed and notarized permit. The signed and notarized permit shall be recorded in the names of all persons listed above and in the names of all owners of record of any portion of the project site on the recordation date.

The project shall not be undertaken or continued unless the project authorized herein is in existence within five years of the date the permit is recorded in the Clinton County Clerk's Office. The Agency will consider the project in existence when the frame and roof of the single family dwelling are constructed.

The project shall be undertaken in compliance with all conditions stated herein. Failure to comply with this permit is a violation and may subject the permittee, successors, and assigns to civil penalties and other legal proceedings.

This permit does not convey any right to trespass upon the lands or interfere with the riparian rights of others in order to undertake the authorized project, nor does it authorize the impairment of any easement, right, title or interest in real or personal property.

Nothing contained in this permit shall be construed to satisfy any legal obligations of the permittee to comply with all applicable laws and regulations or to obtain any governmental approval or permit from any entity other than the Agency, whether federal, State, regional, or local.

PROJECT SITE

The project site is a 17.5±-acre parcel of land located on Hugh Herron Road in the Town of Saranac, Clinton County, in an area classified Resource Management on the Adirondack Park Land Use and Development Plan Map. The site is identified as Tax Map Section 201, Block 1, Parcel 14.2 (Lot 14.2), and is described in a deed from Robert H. Carter and Lucille F. Carter to Alan Sampica and Loraine Sampica, dated September 19, 1978, and recorded November 1, 1978 in the Clinton County Clerk's Office at Book 599, Page 155.

Brittany Locklin and Benjamin Locklin entered into a purchase agreement to purchase and develop Lot 14.2.

PROJECT DESCRIPTION

The project as conditionally approved herein involves the construction of a single family dwelling with attached garage.

The project is shown on the following plans:

- The location of the single family dwelling and limits of clearing are depicted on an un-titled plan prepared by Ben and Brittany Locklin, received by the Agency November 20, 2024 (Site Plan).
- The location and details of the onsite wastewater treatment system are depicted on a two-page set of plans titled "Locklin Residence, Sewage Treatment System" (Septic Plan), prepared by Moser Engineering, received by the Agency November 18, 2024.

A reduced-scale copy of the Site Plan and Septic Plan for the project are attached as a part of this permit for reference.

AGENCY JURISDICTION

Pursuant to Section 809(2)(a) of the Adirondack Park Agency Act, a permit is required from the Adirondack Park Agency prior to the construction of any single family dwelling on Resource Management lands in the Adirondack Park.

CONDITIONS

THE PROJECT IS APPROVED SUBJECT TO THE FOLLOWING CONDITIONS:

1. The project shall not be undertaken until this permit has been recorded in the Clinton County Clerk's Office.
2. This permit is binding on the permittee, all present and future owners or lessees of the project site, and all persons undertaking all or a portion of the project. Copies of this permit and Site Plan and Septic Plan shall be furnished by the permittee to all subsequent owners or lessees of the project site prior to sale or lease, and by the permittee and/or any subsequent owner or lessee to all persons undertaking any development activities authorized herein.

3. In addition to complying with all terms and conditions of this permit, all future activities on the project site shall be undertaken in compliance with the requirements of New York State's Adirondack Park Agency Act, Freshwater Wetlands Act, and the Adirondack Park Agency's implementing regulations [9 NYCRR §§ 570-588].
4. All deeds conveying all or a portion of the lands subject to this permit shall contain references to this permit as follows: "The lands conveyed are subject to Adirondack Park Agency Permit 2024-0300, issued December 23, 2024, the conditions of which are binding upon the heirs, successors and assigns of the grantors and all subsequent grantees."
5. Subject to the conditions stated herein, this permit authorizes the construction of one single family dwelling and one garage on the project site in the location and footprint shown on the Site Plan. The height of the single family dwelling shall not exceed 25 feet as measured from the highest point of the structure to the lower of either existing or finished grade.
6. Construction of any guest cottage on the project site shall require prior written Agency approval.
7. Any on-site wastewater treatment system(s) on the project site installed within five years of the date of issuance of this permit shall be constructed in conformance with the location and design shown on the Septic Plan. Construction of the system shall be supervised by a New York State design professional (licensed engineer or registered architect). Within 30 days of complete system installation and prior to its utilization, the design professional shall provide written certification to the Agency that the system was built in compliance with the approved plans.

No on-site wastewater treatment system shall be installed on the project site more than five years after the date of issuance of this permit except pursuant to written authorization from the Agency.
8. When brought from off-site, all equipment, including but not limited to trucks, excavators, tractors, etc., and hand excavation tools such as shovels, rakes, and picks, to be used on the project site shall be clean and free of soil, mud, or other similar material. If washed on the project site, equipment shall be washed in one location to prevent the distribution of propagules among different wash sites.
9. Any new free-standing or building-mounted outdoor lights shall employ full cut-off fixtures that are fully shielded to direct light downward and not into the sky or toward Hugh Herron Road or adjoining property.
10. The undertaking of any activity involving wetlands shall require a new or amended permit.
11. There shall be no more than one principal building located on the project site at any time. The single family dwelling authorized herein constitutes a principal building.

CONCLUSIONS OF LAW

The Agency has considered all statutory and regulatory criteria for project approval set forth in the Adirondack Park Agency Act and 9 NYCRR Part 574. The Agency hereby finds that the subdivision/single family dwelling authorized as conditioned herein:

- a. will be consistent with the land use and development plan;
- b. will be compatible with the character description and purposes, policies, and objectives of the Resource Management land use area;
- c. will be consistent with the overall intensity guidelines for the Resource Management land use area;
- d. will comply with the shoreline restrictions of § 806 of the Adirondack Park Agency Act; and
- e. will not have an undue adverse impact upon the natural, scenic, aesthetic, ecological, wildlife, historic, recreational or open space resources of the Park or upon the ability of the public to provide supporting facilities and services made necessary by the project.

PERMIT issued this 23rd day of December, 2024.

ADIRONDACK PARK AGENCY

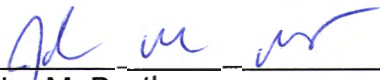
BY: 
John M. Burth
Environmental Program Specialist 3 (EPS3)

STATE OF NEW YORK
COUNTY OF ESSEX

On the 23rd day of December in the year 2024, before me, the undersigned, a Notary Public in and for said State, personally appeared John M. Burth, personally known to me or proved to me on the basis of satisfactory evidence to be the individual whose name is subscribed to the within instrument and acknowledged to me that they executed the same in their capacity, and that by their signature on the instrument, the individual, or the person upon behalf of which the individual acted, executed the instrument.

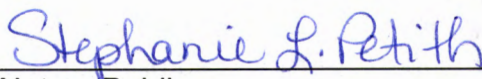
Notary Public

Stephanie L. Petith
Notary Public, State of New York
Reg No 01PE6279890
Qualified in Franklin County
Commission Expires April 15 2) 25

MITCHELL DAVIS

17.5 AC.

384-

Ben-Berryway Lockin

Hugh Heron RD.

201-1-14.2

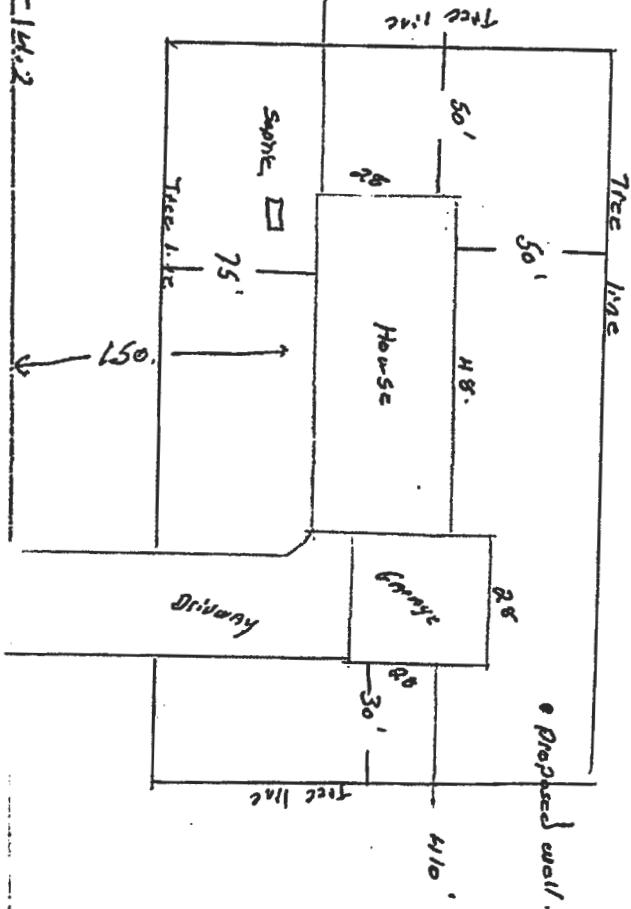

Andrew McCoubert

ADIR
 NEW YORK STATE OF OPPORTUNITY
 Adirondack Park Agency
RECEIVED
 Date: November 20, 2024

ADIR
 NEW YORK STATE OF OPPORTUNITY
 Adirondack Park Agency
FINAL
 P2024-0300

- NOTES:**
- SEPTIC SYSTEM TO COMPLY WITH ALL CHHD REQUIREMENTS, THE INDIVIDUAL RESIDENTIAL WASTEWATER TREATMENT SYSTEMS DESIGN HANDBOOK & ANY MANUFACTURE'S REQUIREMENTS AND BE INSTALLED AS PER THEIR RECOMMENDATIONS.
 - SYSTEM INSTALLER SHALL ENSURE RECD. SEPARATION DISTANCES ARE MET PRIOR TO AND DURING INSTALL.
 - SEE DRAWING C2 FOR DETAILS
 - FILL TO BE PLACED PRIOR TO EXCAVATING TRENCHES AND TO HAVE PERC RATE SIMILAR TO THE USABLE SOIL PERC RATE.
 - THE ENGINEER RECOMMENDS INSTALLING AN EFFLUENT FILTER IN THE SEPTIC TANK. CONTRACTOR TO VERIFY WITH OWNER IF FILTER SHALL BE INSTALLED AND IF SO CONTRACTOR SHALL PROVIDE HOMEOWNER WITH NECESSARY INFORMATION TO MAINTAIN ROUTINE EFFLUENT FILTER CLEANING.
 - A GARBAGE DISPOSAL SHALL NOT BE USED WITH THIS SYSTEM. IF OWNER INSISTS ON A GARBAGE DISPOSAL, A DUAL COMPARTMENT SEPTIC TANK SHALL BE INSTALLED AND THE SIZE OF THE TANK SHALL BE INCREASED BY 250 GALLONS.
 - ANY TREE WITHIN 10' OF ANY SEPTIC SYSTEM COMPONENT SHALL BE REMOVED.
 - IF, AT ANY POINT DURING INSTALLATION, SOIL CONDITIONS ARE ENCOUNTERED THAT VARY FROM THE DEEP HOLE TEST DATA, STOP WORK AND CONTACT THE ENGINEER.
 - SEE THE CLINTON COUNTY HEALTH DEPT PERMIT/APPROVED PLANS FOR ADDITIONAL REQUIREMENTS.
 - THE ENGINEER RECOMMENDS INSTALLING A CLEANOUT JUST OUTSIDE THE HOUSE OR IN THE BASEMENT. THE CONTRACTOR SHALL CONFIRM LOCATION WITH OWNER PRIOR TO INSTALL.
 - THE SEPTIC TANK SHALL BE PUMPED OUT EVERY 3-5 YEARS.
 - SUMP PUMPS, WATER SORTERS, AND ANY OTHER WATER TREATMENT SYSTEMS SHALL NOT DISCHARGE INTO THE SEPTIC TANK.
 - ALL PIPING BETWEEN HOUSE, SEPTIC TANK AND D-BOX SHALL BE INSTALLED AS STRAIGHT AS POSSIBLE AND ANY BEND SHALL NOT EXCEED 45 DEGREES.
 - PRIOR TO EXCAVATING CONTACT DIG SAFELY NEW YORK AT 1-800-962-7962 OR 811.
 - SNOW SHALL NOT BE STOCKPILED ON ABSORPTION FIELD OR SEPTIC TANK.

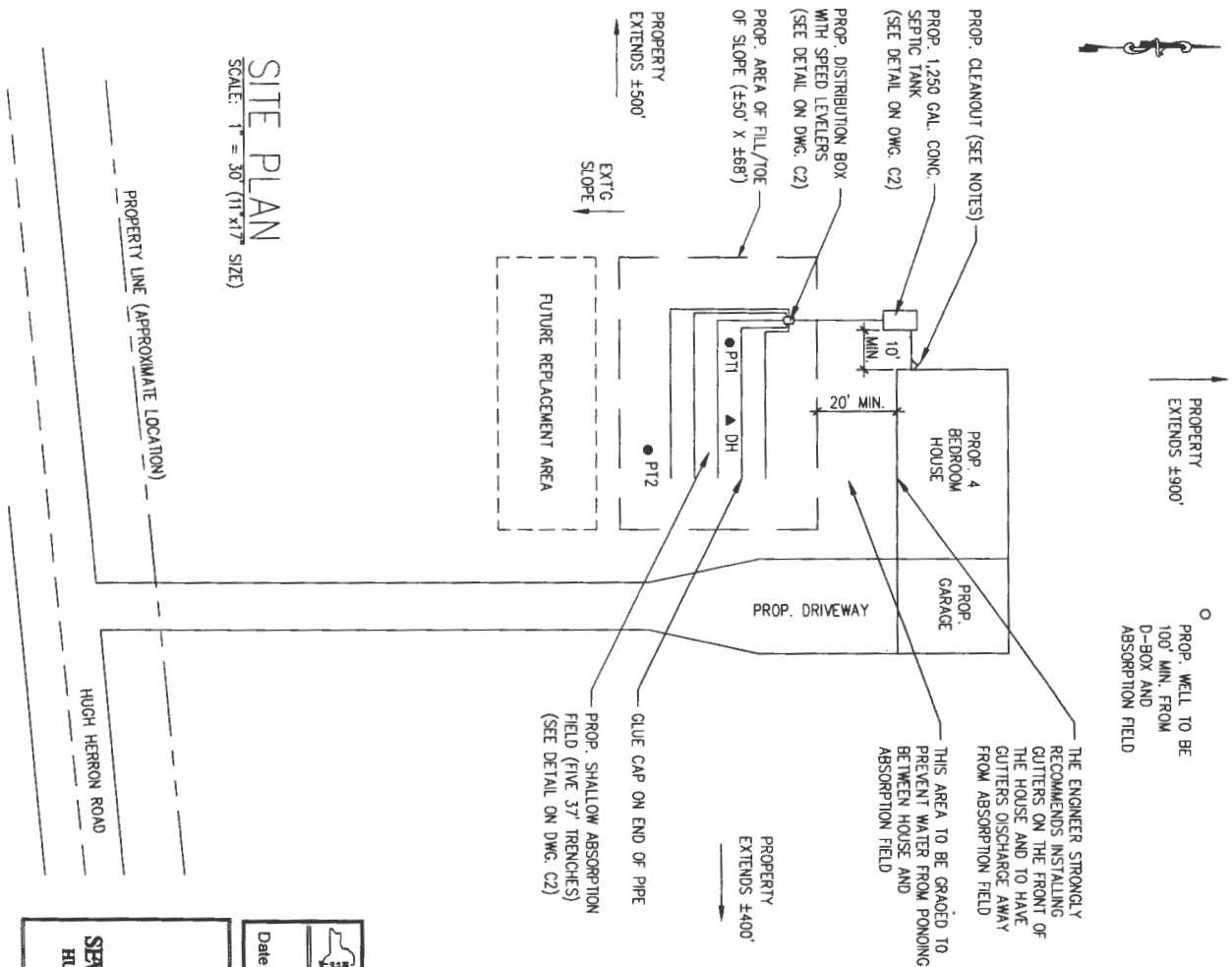

SITE PLAN
SCALE: 1" = 30' (11'x17' SIZE)

DEEP HOLE TEST DATA				
DEPTH (IN.)	SOIL HORIZON	COLOR	TEXTURE	MOTTLING
0-10	LOAM	BLACK	FINE	NO
10-25	SAND/GRAVEL	LIGHT BROWN	COARSE	NO
25-60	LOAMY SAND	BROWN	FINE	NO
TOTAL DEPTH OF USABLE SOIL: 24" (WATER AT 24")				
STABILIZED PERC RATE AT 6" DEEP: 4 MINUTES				

4" OF TOPSOIL & SEED TO BE PLACED OVER ENTIRE ABSORPTION FIELD AFTER INSPECTION

PLOW/SCARIFY EXT'G. SOIL AND THEN PLACE 20" OF FILL PRIOR TO EXCAVATING TRENCHES

BOTTOM OF TRENCH TO BE AT EXT'G. GRADE

DO NOT INSTALL ANY PART OF THE SEPTIC SYSTEM UNTIL THE HEALTH DEPARTMENT HAS ISSUED A PERMIT

ANY CHANGE FROM THE PLAN NEEDS TO HAVE APPROVAL FROM THE ENGINEER AND CHHD PRIOR TO INSTALLATION

RECEIVED

Date: November 18, 2024

FINAL

P2024-0300

LOCKLIN RESIDENCE

SEWAGE TREATMENT SYSTEM

HUGH HERRON ROAD, SARANAC, NY 1288

DATE: X/24

PROJECT NO. 14386

MOSBERG ENGINEERING

13 BAZIN ROAD
CHAZY, NY 12911
518-646-3180
WWW.MOSBERGENGINEERING.COM

C1

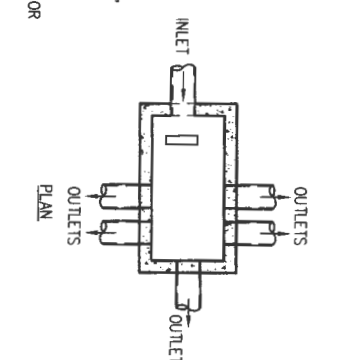
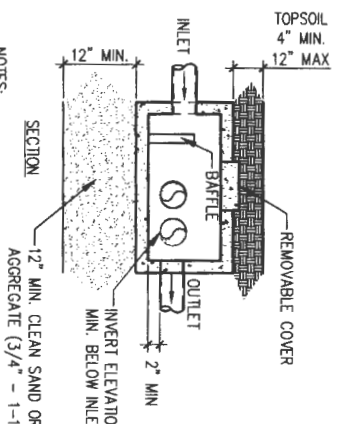
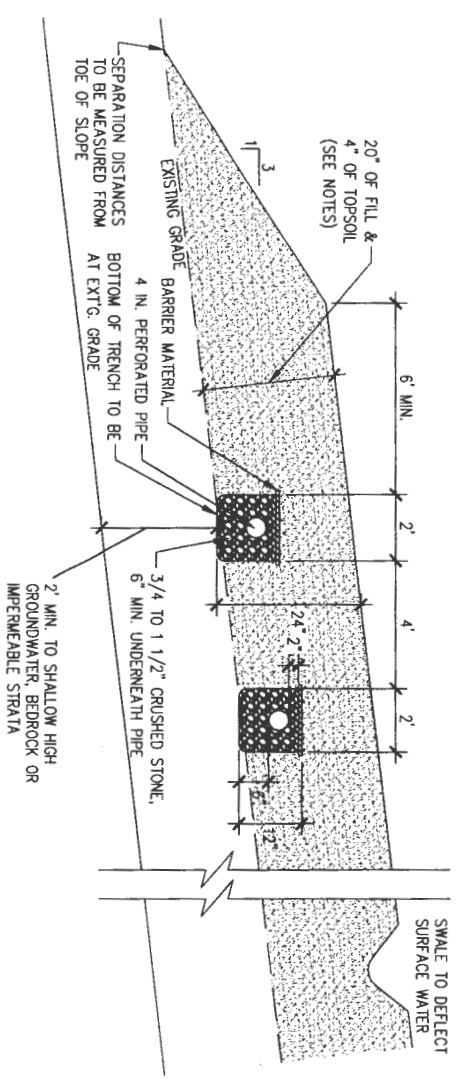
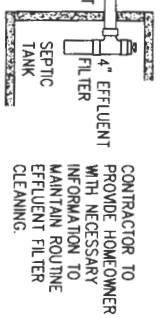
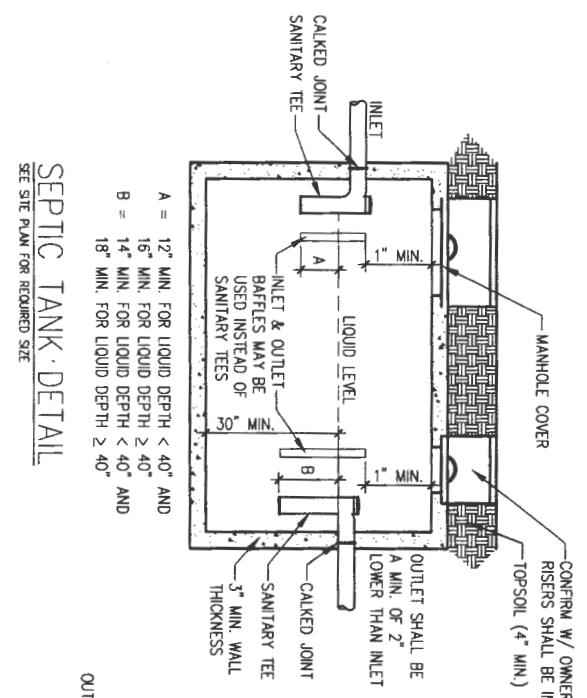

- NOTES:
1. PIPE JOINTS TO BE SEALED WITH ASPHALTIC MATERIAL OR EQUIVALENT.
 2. INVERT ELEVATION OF ALL OUTLET PIPES MUST BE EQUAL. USE OF SPEED LEVELING DEVICES IS RECOMMENDED.
 3. THE PIPE FROM THE SEPTIC TANK TO THE DISTRIBUTION BOX INLET SHALL BE SLOPED AT 1/8" PER FOOT MIN.
 4. THE SLOPE OF OUTLET PIPES BETWEEN THE DISTRIBUTION BOX AND DISTRIBUTION LATERALS SHOULD BE AT LEAST 1/32" PER FOOT.
 5. BAFFLE REQUIRED FOR SIPHON OR AUTOMATIC DOSING OR IF INLET PIPE SLOPE EXCEEDS 1/2" PER FOOT.

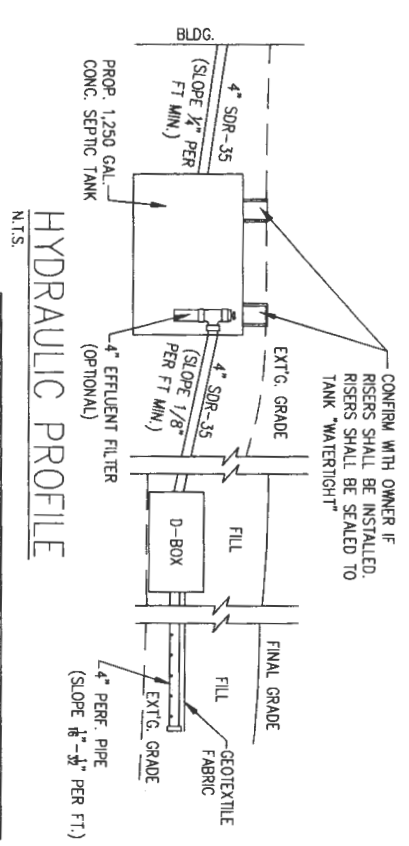

MOBER ENGINEERING
73 BLOOMING ROAD
DARTMOUTH, NH 03825
WWW.MOBERENGINEERING.COM

DETAILS

**LOCKLIN RESIDENCE
SEWAGE TREATMENT SYSTEM**
HUGH HERRON ROAD, SARASOTA, NY 12881
DATE: 03/24
PROJECT NO: 24389

C2